



CMK系列快速接线端子
CMK SERIES PUSH IN QUICK-CONNECTORS

Material of connectors shell: Transparent polycarbonate

Material of actuating levers: Polyamide pom

Material of conductive parts: Thinned copper

Material of contact springs: AISI 301 stainless steel

Rated voltage(V): 450V AC

Rated current(A): 32A

Connection capacity: 0.2-4mm²

Type of electric connection: Equipotential

Working temperature: -40°C to 105°C

Strip length: 11mm/0.43 Inch



Product Code	Connector type	No. of circuits	Flexible wire mm ²	Rigid wire mm ²	Volt (V)	Ampere (A)	Un	Un
CMK-632		2	0.2→2.5	0.2→4	450 V	32 A	100	6000
CMK-633		3					100	4000
CMK-634		4					100	4000
CMK-635		5					50	2000

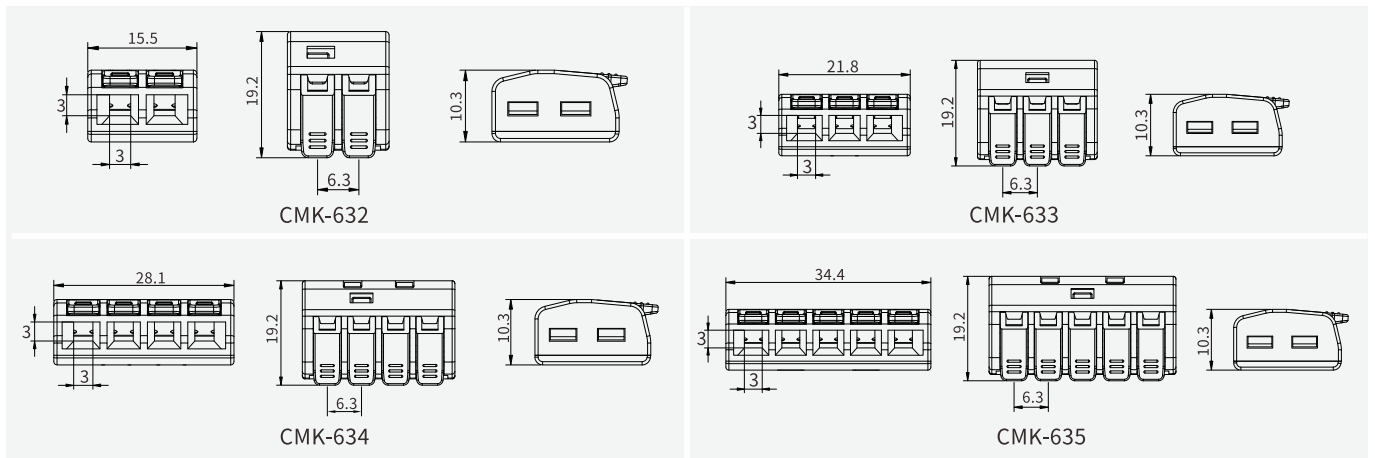



CMK系列快速接线端子 CMK SERIES PUSH IN QUICK-CONNECTORS

Material of connectors shell: Transparent polycarbonate

Material of conductive parts: Thinned copper

Material of contact springs: AISI 301 stainless steel

Rated voltage(V): 450V AC

Rated current(A): 24A







Connection capacity: 0.75-2.5mm²

Type of electric connection: Equipotential

Working temperature: -40°C to 85°C

Strip length: 11mm/0.43 Inch



Product Code	Connector type	No. of circuits	Rigid wire mm ²	Volt (V)	Ampere (A)	Un 	Un 
CMK-252		2	0.75→2.5	450 V	24 A	100	6000
CMK-253		3				100	5000
CMK-254		4				100	4000
CMK-255		5				100	4000



CMK-252(red)
CMK-252X(grey)



CMK-253(orange)
CMK-253X(grey)



CMK-254(yellow)
CMK-254X(grey)



CMK-255(grey)
CMK-255X(grey)

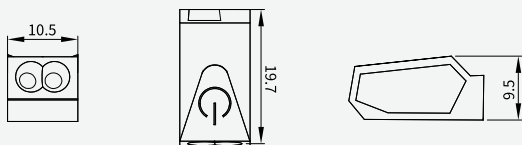

CMK-252

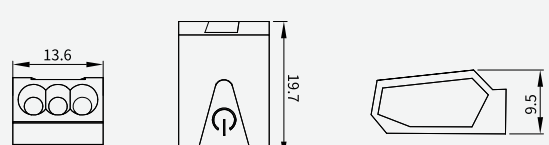

CMK-253

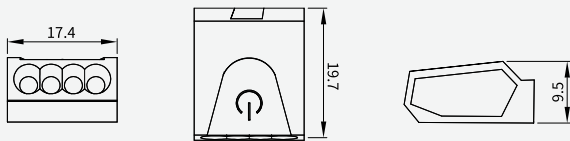

CMK-254

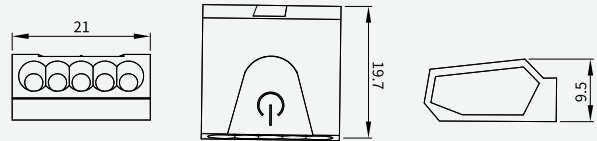







CMK-255



CMK系列快速接线端子
CMK SERIES PUSH IN QUICK-CONNECTORS

Material of connectors shell: Polyamide Pa66
 Material of actuating levers: Polyamide Pa66
 Material of conductive parts: Thinned copper
 Material of contact springs: AISI 301 stainless steel
 Rated voltage(V): 450V AC
 Rated current(A): 32A
 Connection capacity: 0.08-4mm²
 Type of electric connection: Equipotential
 Working temperature: -20°C to 85°C
 Strip length: 11mm/0.43 Inch



Product Code	Connector type	No. of circuits	Flexible wire mm ²	Rigid wire mm ²	Volt (V)	Ampere (A)	Un 	Un 
CMK-412		2	0.08→2.5	0.2→4	450 V	32 A	100	4000
CMK-413		3					100	4000
CMK-414		4					50	2000
CMK-415		5					50	2000



CMK-412



CMK-413



CMK-414



CMK-415

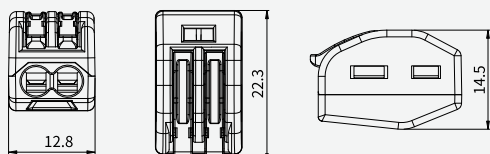

CMK-412

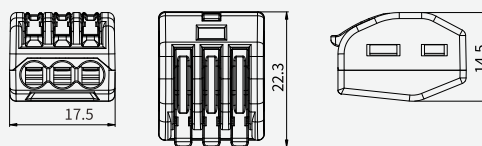

CMK-413

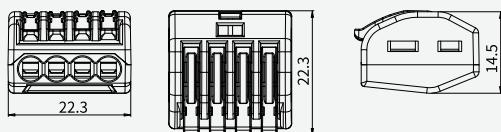

CMK-414

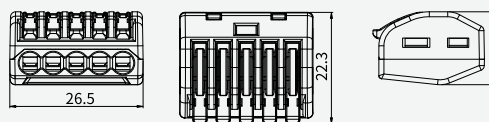

CMK-415



CMK系列快速接线端子 CMK SERIES PUSH IN QUICK-CONNECTORS

Material of connectors shell: Polycarbonate PC
 Material of actuating levers: Polyamide Pa66
 Material of conductive parts: Thinned copper
 Material of contact springs: AISI 301 stainless steel
 Rated voltage(V): 450V AC
 Rated current(A): 32A
 Connection capacity: 0.08-4mm²
 Type of electric connection: Equipotential
 Working temperature: -40°C to 105°C
 Strip length: 11mm/0.43 Inch



Product Code	Connector type	No.of circuits	Flexible wire mm ²	Rigid wire mm ²	Volt (V)	Ampere (A)	Un	Un
CMK-421		2	0.08→2.5	0.2→4	450 V	32 A	50	2000
CMK-401		2					50	3000
CMK-422		4					50	1500
CMK-423		6					50	2000
CMK-424		8					50	1000
CMK-425		10					50	1800

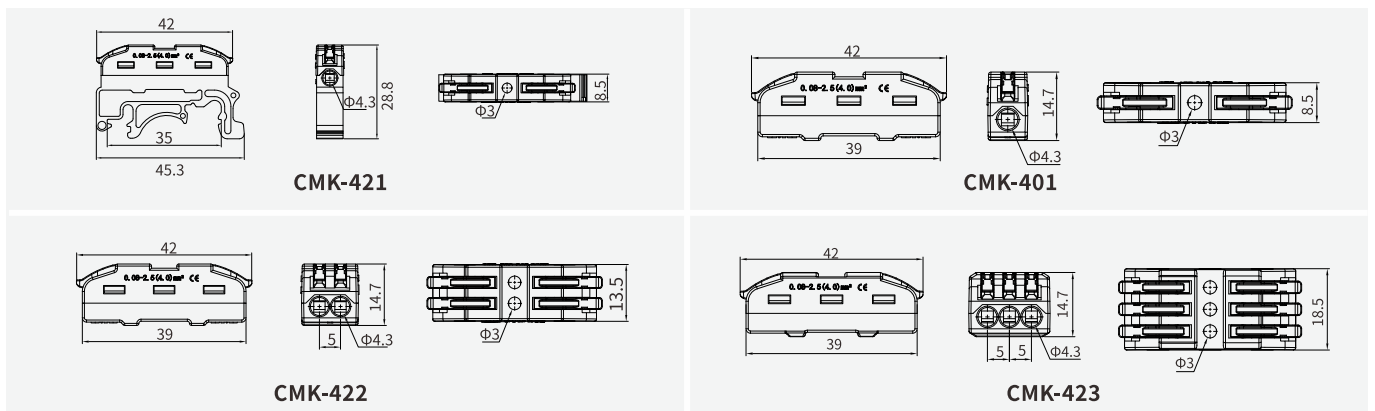



CMK系列快速接线端子
CMK SERIES PUSH IN QUICK-CONNECTORS

Material of connectors shell: Polycarbonate PC
 Material of actuating levers: Polyamide Pa66
 Material of conductive parts: Thinned copper
 Material of contact springs: AISI 301 stainless steel
 Rated voltage(V): 450V AC
 Rated current(A): 32A
 Connection capacity: 0.08-4mm²
 Type of electric connection: Equipotential
 Working temperature: -40°C to 105°C
 Strip length: 11mm/0.43 Inch



Product Code	Connector type	No. of circuits	Flexible wire mm ²	Rigid wire mm ²	Volt (V)	Ampere (A)	Un	Un
CMK422-4		6	0.08→2.5	0.2→4	450 V	32 A	40	1600
CMK422-6		8					30	1200
CMK422-8		10					20	800
CMK421-2		3					50	3000
CMK421-3		4					50	3000
CMK421-4		5					50	3000



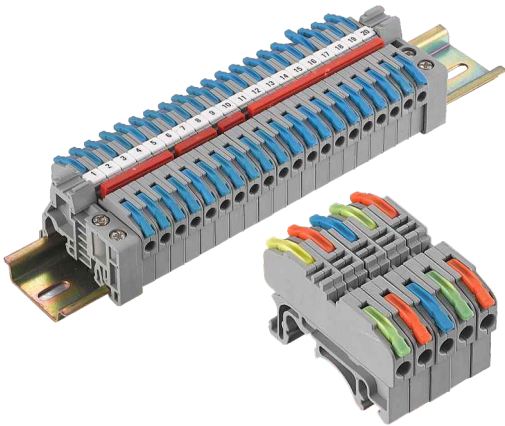



CMK系列快速接线端子 CMK SERIES PUSH IN QUICK-CONNECTORS

Material of connectors shell: Polyamide Pa66
 Material of actuating levers: Polyamide Pa66
 Material of conductive parts: Thinned copper
 Material of contact springs: AISI 301 stainless steel
 Rated voltage(V): 450V AC
 Rated current(A): 32A
 Connection capacity: 0.08-4mm²
 Type of electric connection: Equipotential
 Working temperature: -20°C to 85°C
 Strip length: 11mm/0.43 Inch



Product Code	Connector type	No. of circuits	Flexible wire mm ²	Rigid wire mm ²	Volt (V)	Ampere (A)	Un	Un
CMK-420		2	0.08→2.5	0.2→4	450 V	32 A	25	1500
CMK-420J		2	0.08→2.5	0.2→4	450 V	32 A	25	1500





CMK系列快速接线端子
CMK SERIES PUSH IN QUICK-CONNECTORS

Material of connectors shell: Transparent polycarbonate

Material of conductive parts: Thinned copper

Material of contact springs: AISI 301 stainless steel

Rated voltage(V): 450V AC

Rated current(A): 24A

Connection capacity: 0.5-2.5mm²

Type of electric connection: Equipotential

Working temperature: -40°C to 85°C

Strip length: 11mm/0.43 Inch



Product Code	Connector type	No. of circuits	Rigid wire mm ²	Volt (V)	Ampere (A)	Un	Un
CMK-202		2	0.5→2.5	450 V	24 A	150	9000
CMK-203		3				100	6000
CMK-204		4				100	6000
CMK-205		5				10	6000
CMK-206		6				50	3000
CMK-208		8				50	3000

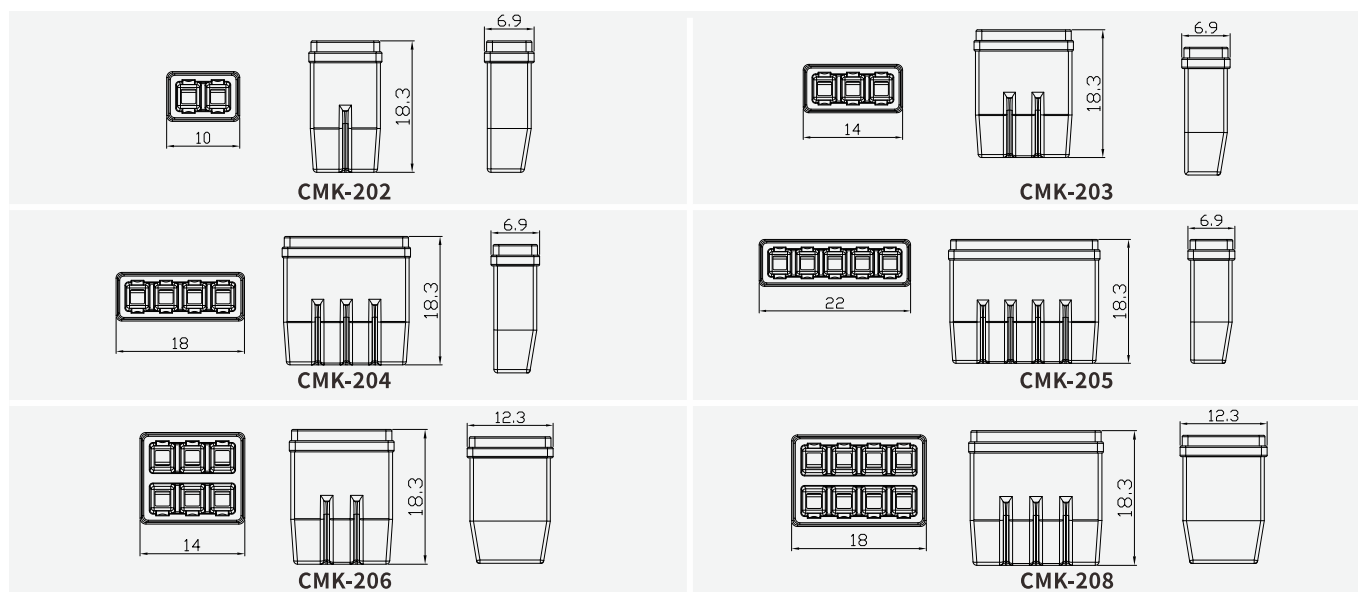









CMK系列快速接线端子
CMK SERIES PUSH IN QUICK-CONNECTORS

Material of connectors shell: Transparent polycarbonate
 Material of actuating levers: Polyamide Pom
 Material of conductive parts: Thinned copper
 Material of contact springs: AISI 301 stainless steel
 Rated voltage(V): 450V AC
 Rated current(A): 32A
 Connection capacity: 0.75-2.5mm²
 Type of electric connection: Equipotential
 Working temperature: -40°C to 105°C
 Strip length: 13mm/0.51 Inch



Product Code	Connector type	No. of circuits					 Un	 Un
CMK-612		2	1.0→2.5	0.75→2.5	450 V	32 A	100	6000
CMK-613		3					100	4000
CMK-614		4					100	4000
CMK-615		5					100	4000



CMK-612







CMK-613



CMK-614



CMK-615

Product Code	Connector type	No. of circuits	Rigid wire mm ²	Flexible wire mm ²	Volt (V)	Ampere (A)	 Un	 Un
CMK-101		1-1	0.5→2.5	1.0→2.5	450 V	24 A	100	6000
CMK-112		1-2					100	4000
CMK-201		1-1					50	2000

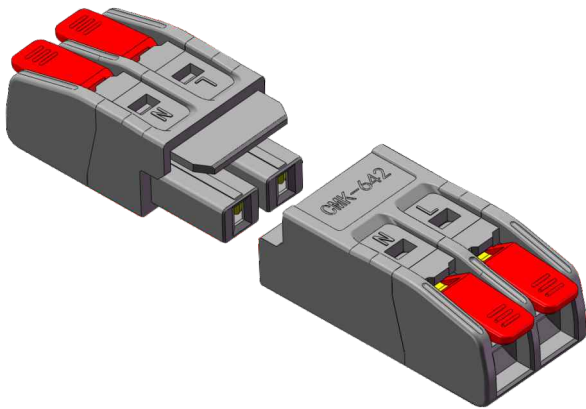

CMK系列快速接线端子
CMK SERIES PUSH IN QUICK-CONNECTORS

Material of connectors shell: Polycarbonate PC
 Material of actuating levers: Polyamide Pa66
 Material of conductive parts: Thinned copper
 Material of contact springs: AISI 301 stainless steel
 Rated voltage(V): 450V AC
 Rated current(A): 32A
 Connection capacity: 0.08-4mm²
 Type of electric connection: Equipotential
 Working temperature: -40°C to 105°C
 Strip length: 11mm/0.43 Inch



Product Code	Connector type	No. of circuits	Flexible wire mm ²	Rigid wire mm ²	Volt (V)	Ampere (A)	Un	Un
CMK-642		4	0.2-2.5	0.2-4	450V	32A	30	1200
CMK-643		6					20	800



CMK-651



CMK-652



CMK-653



CMK-655

Product Code	Connector type	No. of circuits	Flexible wire mm ²	Rigid wire mm ²	Volt (V)	Ampere (A)	Un	Un
CMK-651		2	0.2-2.5	0.2-4	450V	32A	50	3000
CMK-652		4					50	2000
CMK-653		6					40	1600
CMK-655		10					25	1000

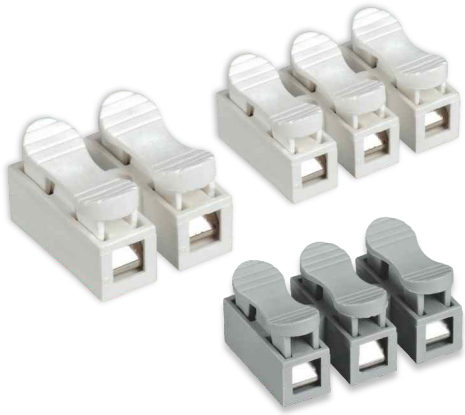

CMK系列快速接线端子
CMK SERIES PUSH IN QUICK-CONNECTORS

Material of connectors shell: Polypropylene
 Material of conductive parts: Thinned copper
 Material of contact springs: AISI 301 stainless steel
 Rated voltage(V): 450V AC
 Rated current(A): 5A,10A,25A
 Connection capacity: 0.2-6mm²
 Type of electric connection: Equipotential
 Working temperature: -20°C to 90°C
 Strip length: 11mm/0.43 Inch

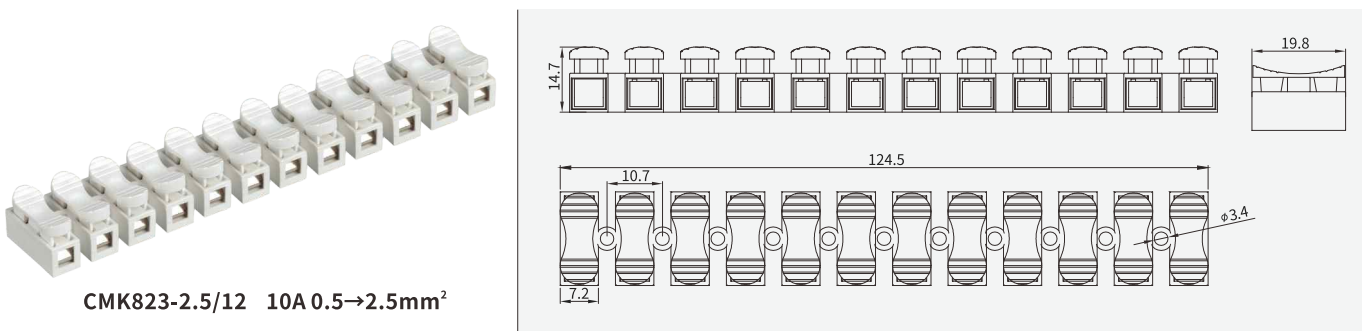
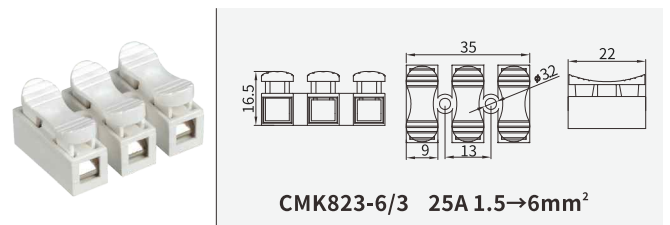
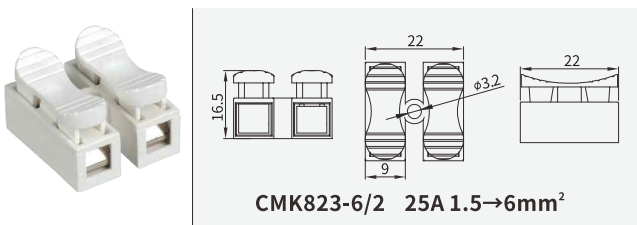
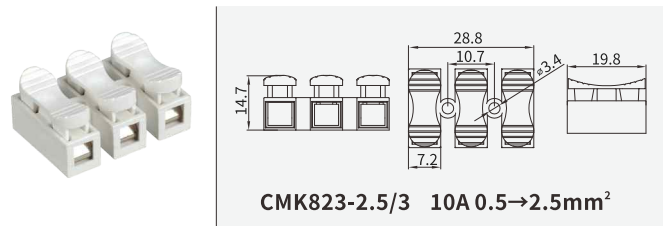
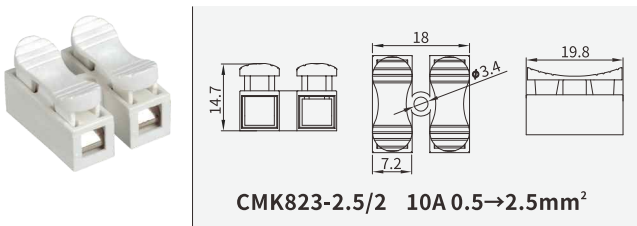
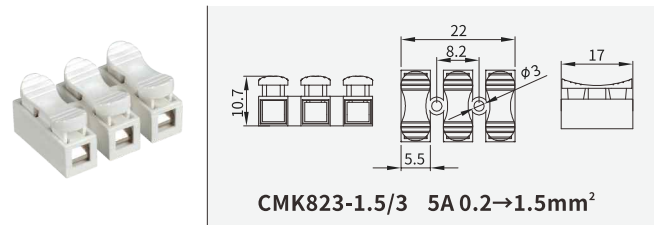
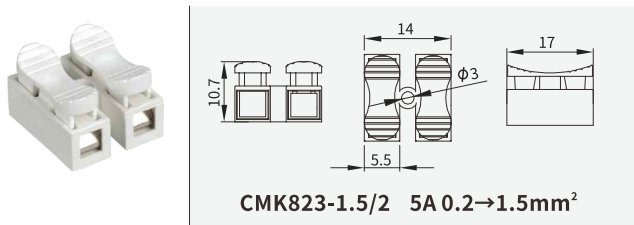

CMK系列快速接线端子
CMK SERIES PUSH IN QUICK-CONNECTORS
PUSH IN CONNECTORS SERIES



Product Code	Wire section (mm ²)	Current	Voltage
CMK923-2	0.2~2.5mm ²	25A	380V
CMK923-3			
CMK923-4			
CMK923-5			

(*can add handle and earth lug)

PUSH IN CONECTORS SERIES



Product Code	Wire section (mm ²)	Current	Voltage
CMK-601	in 2.5-6 (one wire) out 0.3-1.5 (two wire)	10A	220V
CMK-602			
CMK-603			

CERAMICS TERMINAL BLOCK SERIES



Product Code	Wire section (mm ²)	Current	Voltage	Hole
2W5H-5A	4	5A	400V	2
2W5H-10A	10	10A		
2W5H-15A	12	15A		
2W5H-30A	16	30A		
3W8H-5A	4	5A	400V	3
3W8H-10A	10	10A		
3W8H-15A	12	15A		
3W8H-30A	16	30A		

2/3 POLES CONNECTOR



Product Code	mm ²	Volt/Pole	L	W	H	h	E	e
CMK1002	6	380V/2P	15.7	18.6	15.2	8.5	12.3	6.6
CMK1003		380V/3P	25.5					

H SERIES FIXED TERMINAL BLOCKS

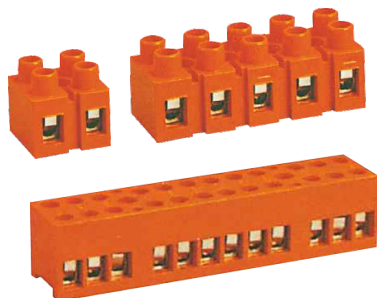

Product Code	mm ²	Amp	Volt
JH2519-2/3/5/10/12	0.5-6	36A	600V
JH3801-6/10/12			